

NOTE:

- 1) DISTANCE BETWEEN THE FACE OF THE HOISTWAY DOOR AND EDGE OF LANDING SILL SHALL NOT EXCEED 3/4".
- 2) MUST REJECT 4" DIAMETER BALL AT ALL POINTS WHEN HOISTWAY DOOR AND CAR DOOR ARE IN FULLY CLOSED POSITION.
- 3) HOISTWAY BY OTHERS PER CODE. WALLS TO BE PLUMB AND SQUARE. ALL HOISTWAY DOORS BY OTHERS PER CODE.
- 4) HOISTWAY DOOR INTERLOCKS BY OTHERS.
- 5) FINISHED HOISTWAY = ROUGH FRAMING + DRYWALL + PLASTER + PAINT.

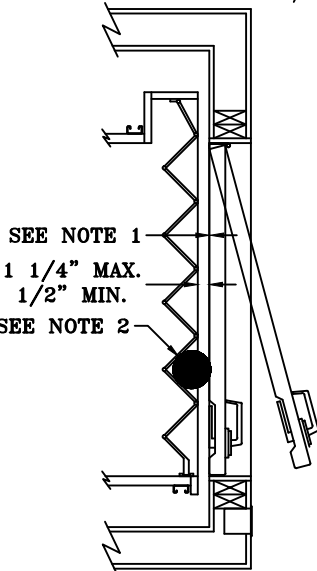
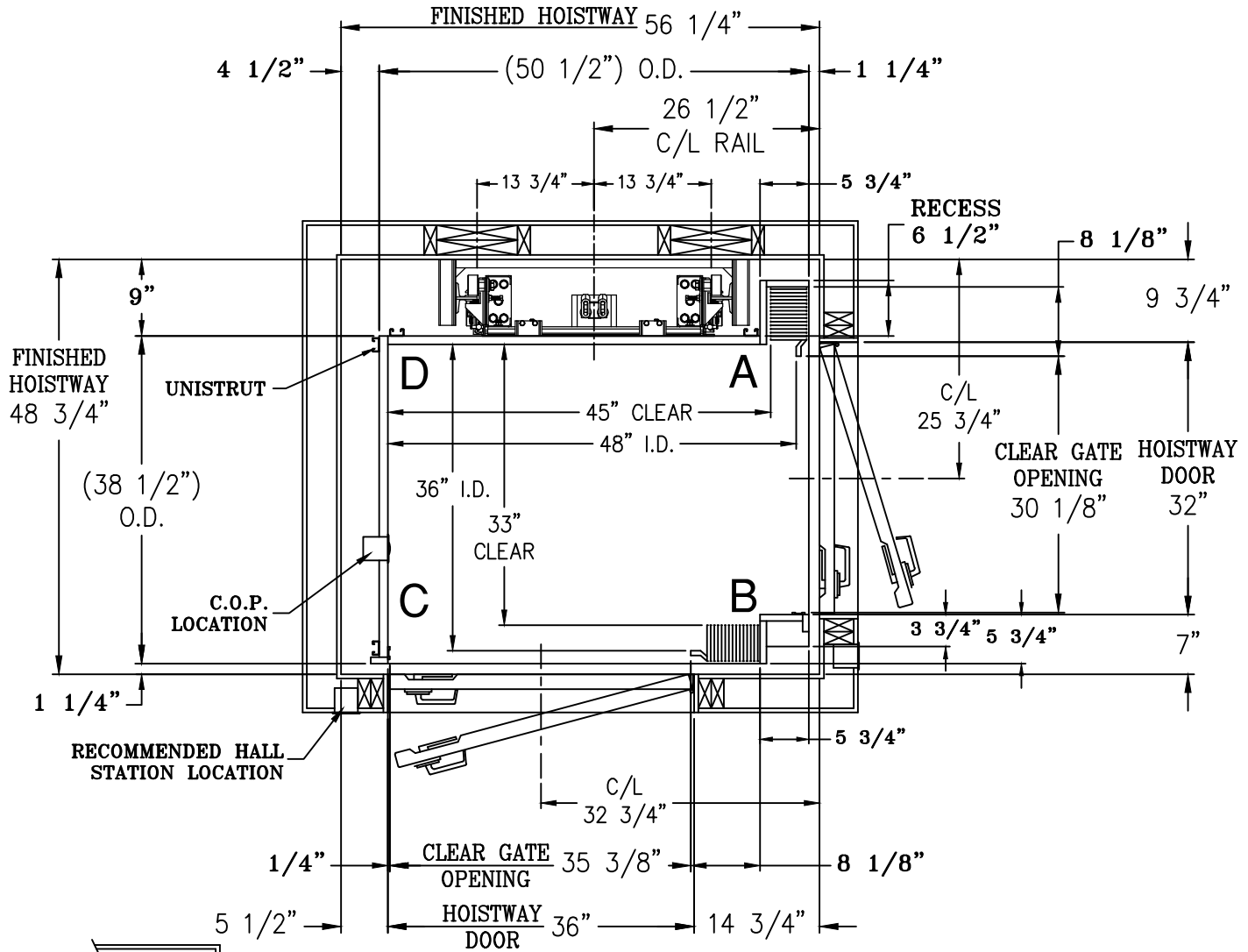

**Waupaca**  
ELEVATOR COMPANY™

1726 North Ballard Road  
Appleton, WI 54911  
Phone: 800-238-8739

ELEVATOR CONTRACTOR:			
JOB NAME:		ORDER NUMBER:	
<b>EXCELEVATOR SERIES WINDING DRUM ELEVATOR ABR BC OPENING W/ ACCORDION GATE</b>			
DRAWN BY:	DATE:	SIGNATURE OF APPROVAL	DWG. NO. C-002878